

B205

(1) Start a class

codemari is a web application for operating AV devices. It can turn on/off the projector, switch images, and adjust volume.
(NOTE) The Blue-ray player is controlled by a remote control located in the AV rack.

(1) Remove iPad from the AV rack

Take the iPad that controls codemari out of the AV rack.
 When the iPad is in sleep mode, lightly press Power or Home.



(2) Turn on the main power of codemari

When the codemari system startup window appears, press ON.
 After a few moments, the Home window will appear, and the AV device is ready to use.
 * If the main power is ON, the Home window will appear as it is.



* If codemari has logged out...

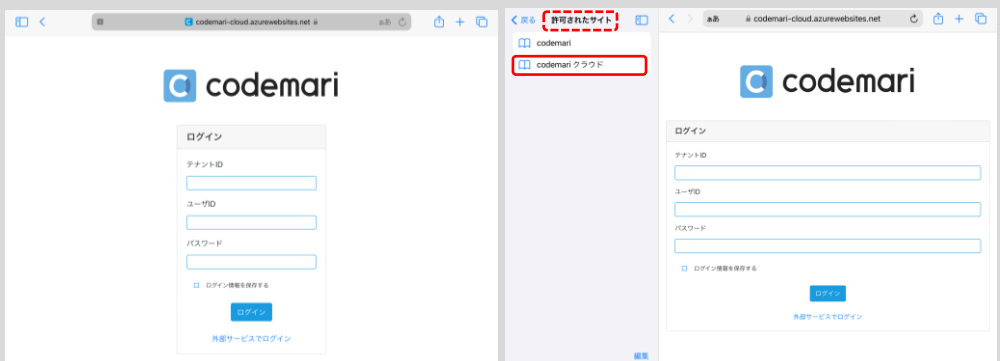

After the iPad starts up, it automatically connects to Sophia Wi-Fi and Safari will start up.
 Select [codemari Cloud] from the bookmarks and go to **Sophia University Login**.

Be sure to log in from **Sophia University Login**.
 Use the login ID/password stored in the iPad.

(2) Finish the class

(1) Exit codemari

Press  in the upper-right corner of all windows to turn off the main power of codemari.



(2) Make sure that codemari is closed

When the iPad returns to the system startup window, codemari is turned off. Please turn off the overhead camera as it is not linked to codemari.



(3) Charge iPad

After using codemari, please return the iPad to its charging state.

*Use the lightning cable for charging the iPad in the AV rack.

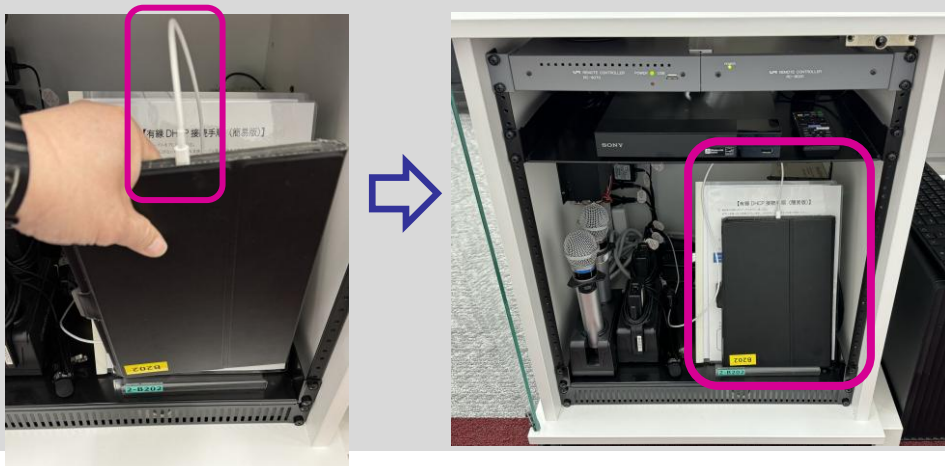

Do not log out to exit codemari.
Logging out does not turn off codemari.
Also, please do not forcibly turn OFF the iPad.

■ For details on how to use codemari, please refer to "Codemari Operating Manual".

It is located beside the iPad.



(3) Use Easy Setup

(1) Home window

From the home window of this codemari, selecting each function will navigate to the operation window of the corresponding function.



(2) Use Easy Setup

On the Home window, press  to access Easy Setup. You can operate the devices all at once based on preset scenarios.



* The list of registered easy settings is on page 4.

 If codemari doesn't work properly...

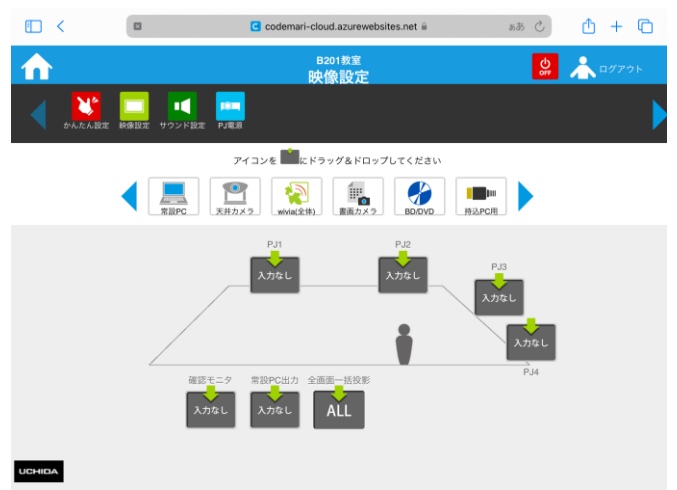
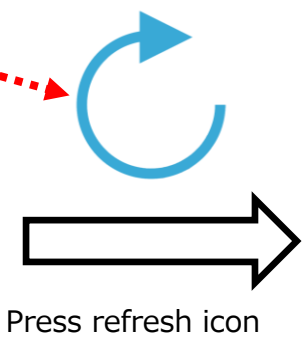
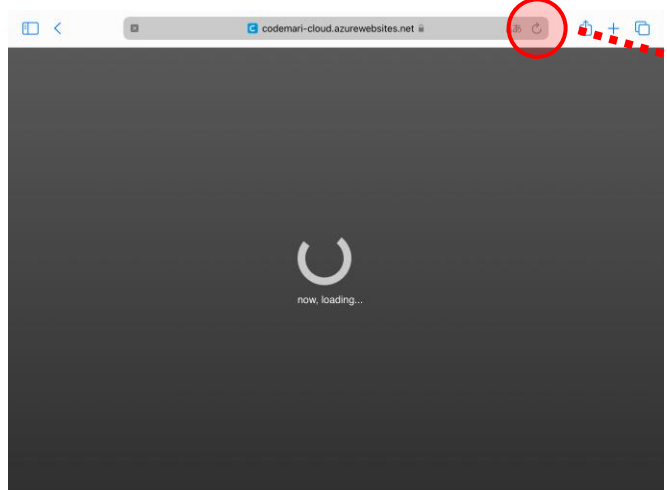

Details of Easy Setups (Room B205)

	Scenario name	Video	Sound source	Projectors
1	Start the lecture on your PC (Return)	PJ1:- For your PC PJ2:- For your PC PJ3:- For your PC PJ4:- For your PC Teacher's desk PC output: No input Check monitor:- For your PC	For your PC	PJ1:- ON PJ2:- ON PJ3:- ON PJ4:- ON
2	Start the lecture on teacher's desk PC (Return)	PJ1:- Teacher's desk PC PJ2:- Teacher's desk PC PJ3:- Teacher's desk PC PJ4:- Teacher's desk PC Teacher's desk PC output: No input Check monitor:- Teacher's desk PC	Teacher's desk PC	PJ1:- ON PJ2:- ON PJ3:- ON PJ4:- ON
3	Student presentations on their PCs (1 to 4 students)	PJ1:- Wivia(PJ1) PJ2:- Wivia(PJ2) PJ3:- Wivia(PJ3) PJ4:- Wivia(PJ4) Teacher's desk PC output: (retain previous source) Check monitor:- (Retain previous source)	(Retain previous source)	PJ1:- ON PJ2:- ON PJ3:- ON PJ4:- ON
4	Student presentations on their PCs (1 to 2 students)	PJ1:- (Retain previous source) PJ2:- (Retain previous source) PJ3:- Wivia(PJ3) PJ4:- Wivia(PJ4) Teacher's desk PC output: (retain previous source) Check monitor:- (Retain previous source)	(Retain previous source)	PJ1:- ON PJ2:- ON PJ3:- ON PJ4:- ON
5	Activate the camera for web conferencing	PJ1:- (Retain previous source) PJ2:- (Retain previous source) PJ3:- (Retain previous source) PJ4:- (Retain previous source) Teacher's desk PC output: Ceiling camera Check monitor:- Ceiling Camera	(Retain previous source)	PJ1:- ON PJ2:- ON PJ3:- ON PJ4:- ON

- * For a web conference, connect one USB cable for video capture and one USB cable for microphone audio capture to the PC. Please check that Zoom settings are as follows.
- Camera: USB Capture HDMI
 - Speaker: CRO-UIL2AT (Audio for Intel(R) display)
 - Microphone: Echo canceling speakerphone (DIGITAL SMARTMIXER...)

Details of Easy Setups (Room B205)

- (1) Start the lecture on your PC (Return)
- (2) Start the lecture on teacher's desk PC (Return)

- (3) Student presentations on their PCs (1 to 4 students)

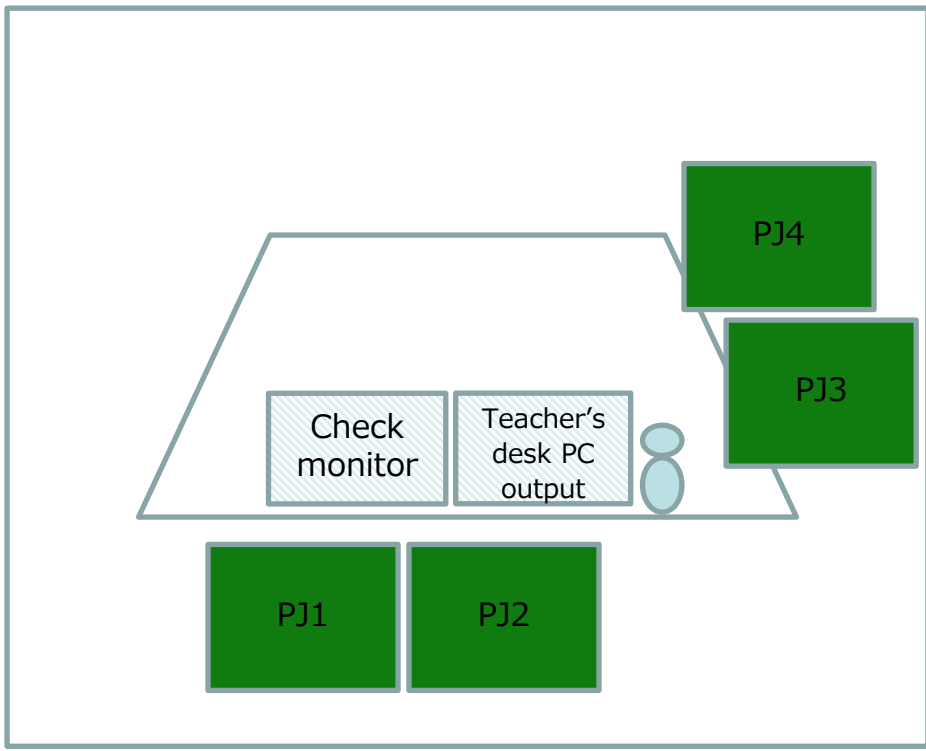
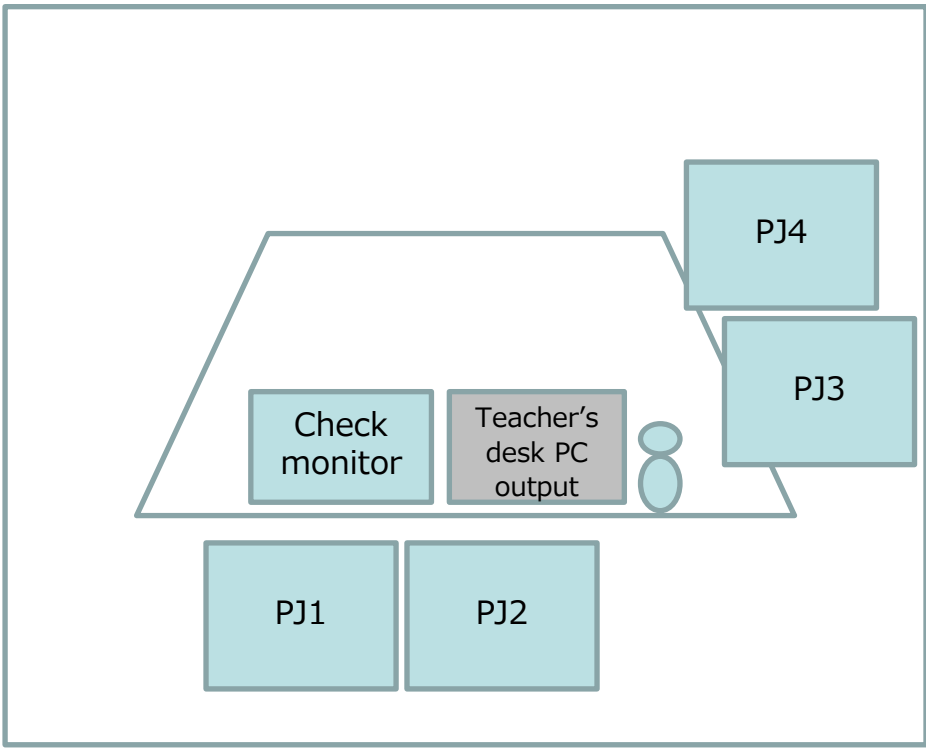

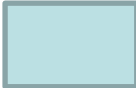
 BYO/teacher's desk PC video

 No Input

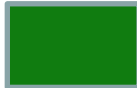
 wivia video

 Retain the previous input source

(4) Student presentations on their PCs (2 students)

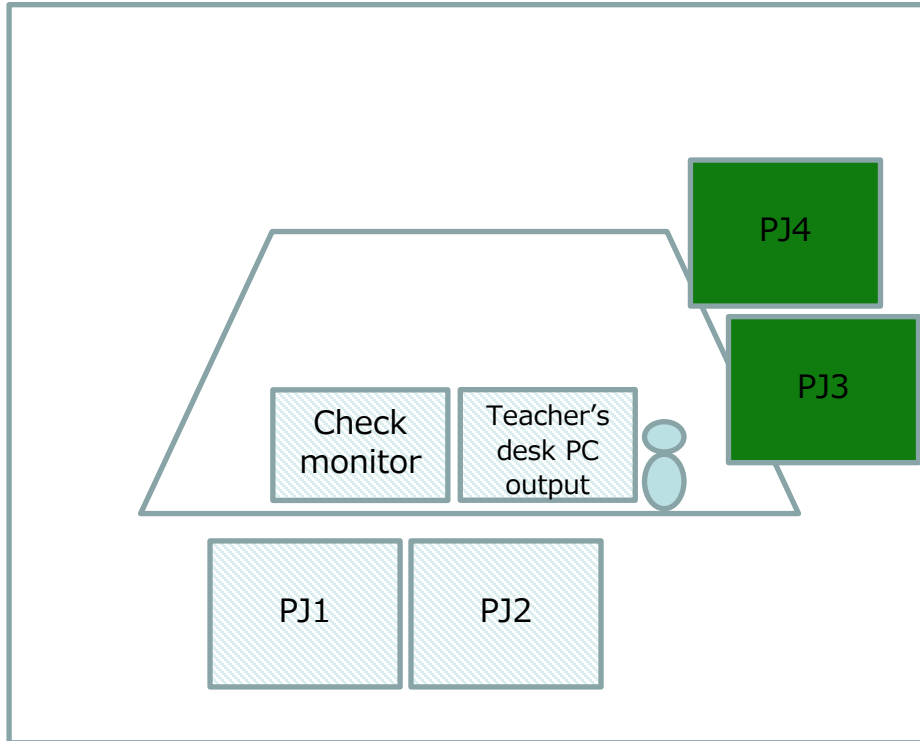

wivia video



Retain the previous input source

(4) Activate the camera for web conferencing

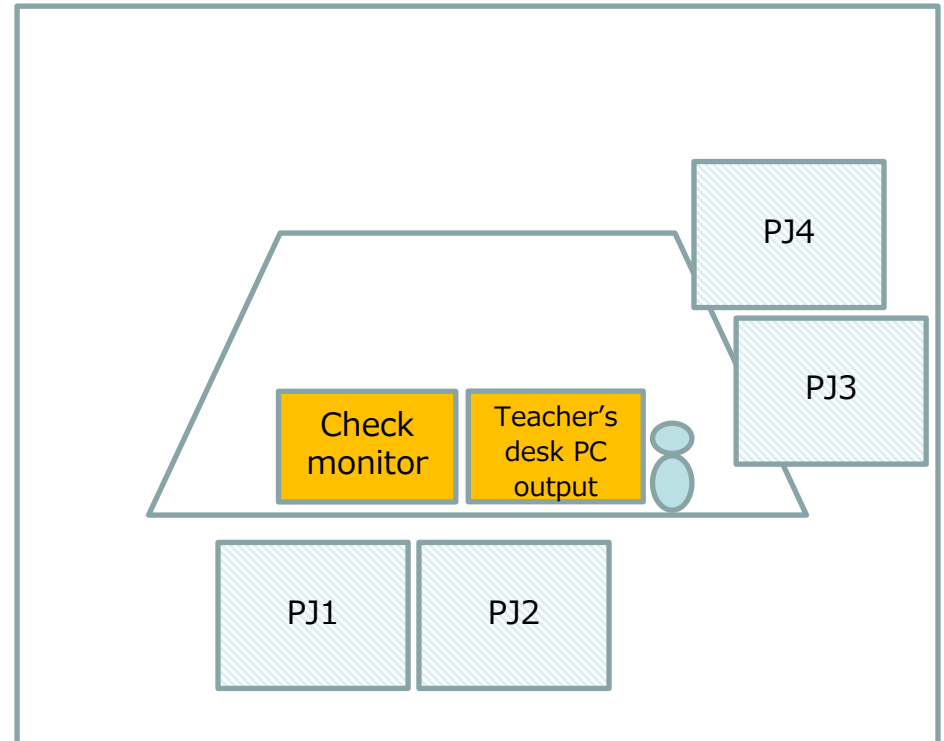

Ceiling camera view



Retain the previous input source

(4) Use codemari's other functions

In addition to using the pre-registered easy settings, codemari allows you to switch to any desired video, turn the projector on or off individually, and adjust the volume by accessing the windows of each function.

Select the desired function from the Home window

Select the desired function from the Home window.

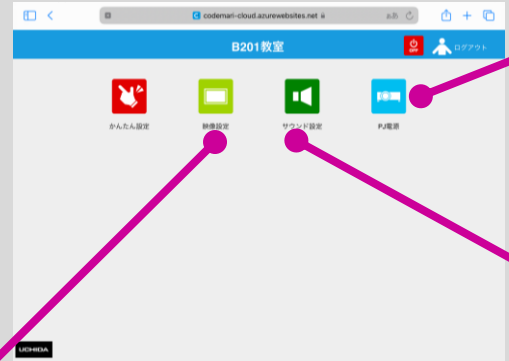

[Projector Operation]

Perform the power control and mute operation of each projector.

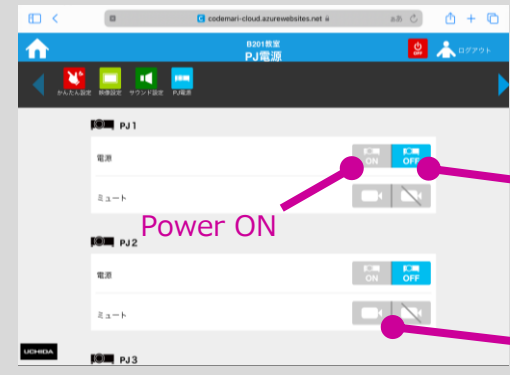

[Video Settings]

Display the image on the destination devices. Select the image source to project from the buttons displayed at the top of the screen and assign it by **dragging and dropping** it into the frame of the projector or monitor to use.

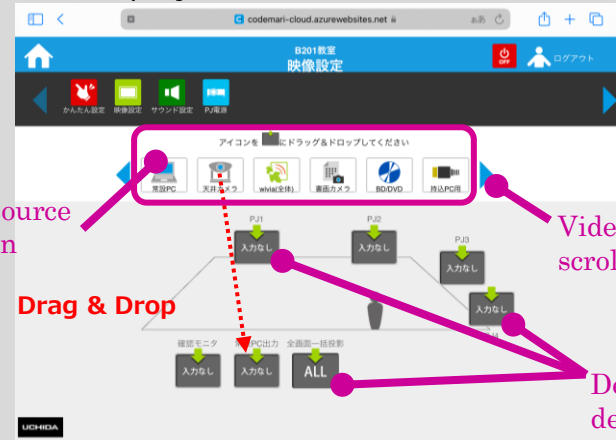

[Sound Settings]

In this window, select the sound source for the speakers, and adjust the volume of the speakers and microphone.

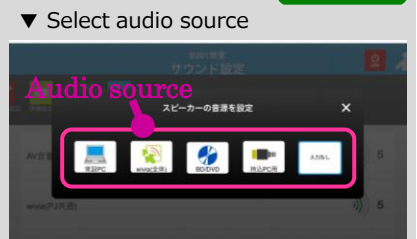

教室 AV システムについての問い合わせ先 Inquiries for Classroom AV Systems

教室 AV システムに関するお問い合わせは、情報システム室 **ICT 授業支援デスク**までお願いいたします。

For classroom AV system inquiries, please contact the **ICT Faculty Support Desk**.

ICT 授業支援デスク

2号館 1階(2-112室)

Tel: **03-3238-4311** Ext: 4311

授業期間: **8:30~19:30**

ICT Faculty Support Desk

Building 2, 1st floor (Room 2-112)

Tel: **03-3238-4311** Ext: 4311

OPEN: **8:30~19:30** (During class period)

電話番号/
Phone Number



メールアドレス/
Mail Address

